

DUAL-PLATE WAFER CHECK VALVE

Model : ARV-809WT(U)-S

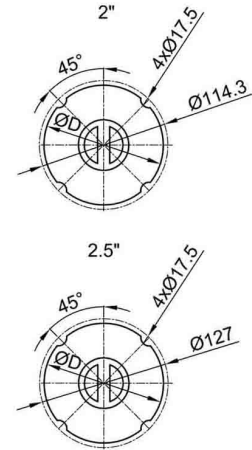
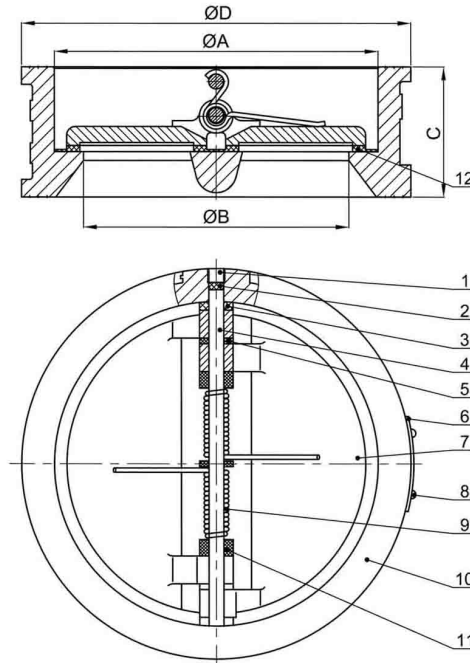

Technical Data

Design Standard

Design Standard	API 594
Face to Face	EN 558
Flange Connection	Arita Universal Standard (Include Ansi 150, JIS 10K, EN1092 PN 10/16, AS 2129 Table E)
Test Standard	EN 12266-1

Hydrostatic Test

Pressure Rating	PN 10 / PN 16
Shell Test Pressure	1.5 / 2.4 Mpa
Seal Test Pressure	1.1 / 1.76 Mpa
Suitable Temperature	-20 to 130 °C (EPDM)

Material

No	PART	MATERIAL
1	SCREW	SS 304
2	STEM WASHER	EPDM
3	DISC RING	PTFE
4	SHAFT	SS 304
5	WASHER	PTFE
6	NAME PLATE	ALUMINIUM
7	DISC	CF8
8	RIVET	ALUMINIUM
9	SPRING	SS 304
10	BODY	CAST IRON
11	WASHER	PTFE
12	SEAT	EPDM

Dimension in mm

DN	40	50	65	80	100	125	150	200	250	300	350	400	450	500	600
NPS	1.5"	2"	2.5"	3"	4"	5"	6"	8"	10"	12"	14"	16"	18"	20"	24"
A	65	65.8	78.8	94.8	116.2	145	170	222	265	310	360	410	450	505	624
B	-	40	58	70	88	115	134	182	220	260	302	350	385	438	538
C	43	43	46	64	64	70	76	89	114	114	127	140	152	152	178
ØD	92	101	121	129	156	187	213	267	327	375	420	483	537	592	695
Wt. (kg)	1.2	1.4	1.9	3.0	4.6	6.0	7.9	15.8	25.4	36.9	54.2	78.0	107.8	122.1	171.2

The contents of this literature are for informative purposes only. Arita is not responsible for suitability or compatibility of these products in relation to system requirement. For specific requirements, consult Arita or its distributors. Arita reserves the right to change or modify product design without prior notice.